



HOW TO MAKE A CREATURAMA DINOSAUR

Artist Anthony James creates his dinosaur models by using recycled materials.

If you want to build your own prehistoric creature, here's how to do it.

PRESTOSUCHUS

5m long. Lived in the late Triassic Period. Meat eater.

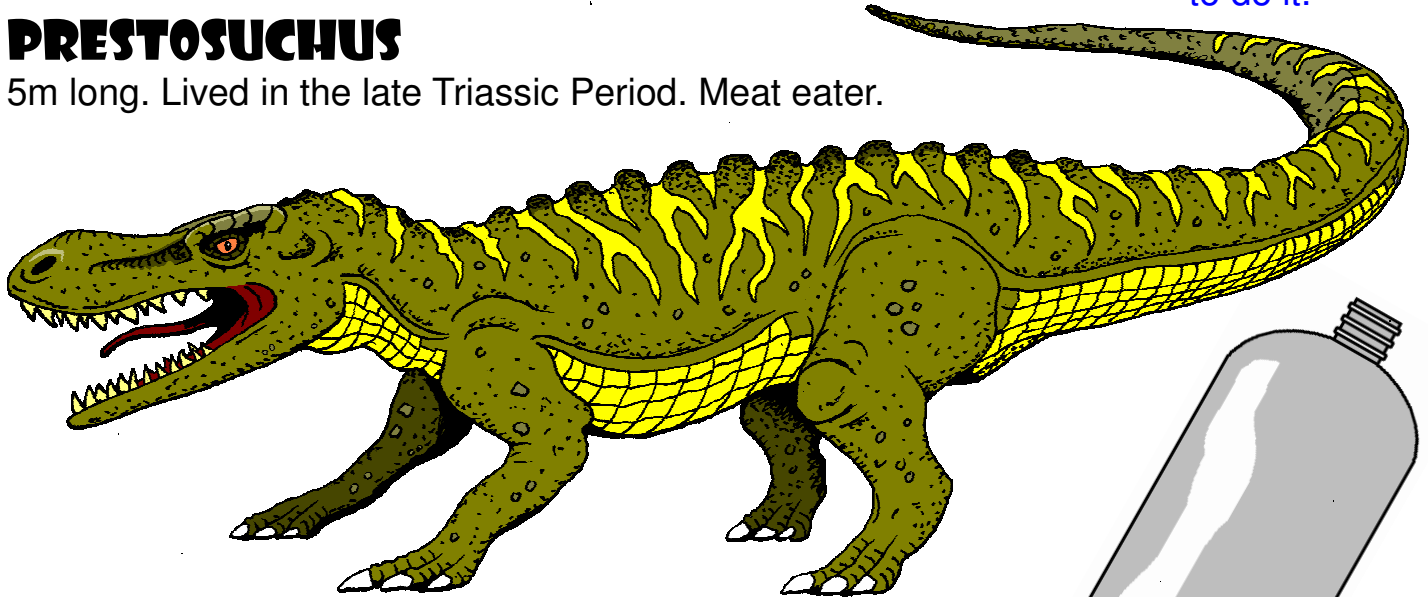

What You Will Need

A Roll of WIDE Masking Tape. Small Scissors. A Cereal Box. A Large plastic Pop Bottle. Toilet or Kitchen rolls (at least 2 Kitchen or 4 toilet rolls). Newspaper. Coloured Paper. Water based (ready mixed) paint. Some brushes.

STEP 1 The Body

The first thing you will need is a roll of **WIDE** masking tape, which is brilliant for making all kinds of models. The second thing you will need is a large plastic pop bottle. Make sure it is thoroughly washed out before you use it, dry with its top on.

Now tear off or cut off one page of a standard sized newspaper and crumple this up in your hand. Once this is done re-open the page and lay it flat on a table. Now stick masking tape all around it, half on and half off, effectively sticking it down onto the table. Only do this if you have an unvarnished worktop or a work table. You now have a large patch of newspaper which can be rolled around your plastic bottle and stuck down.

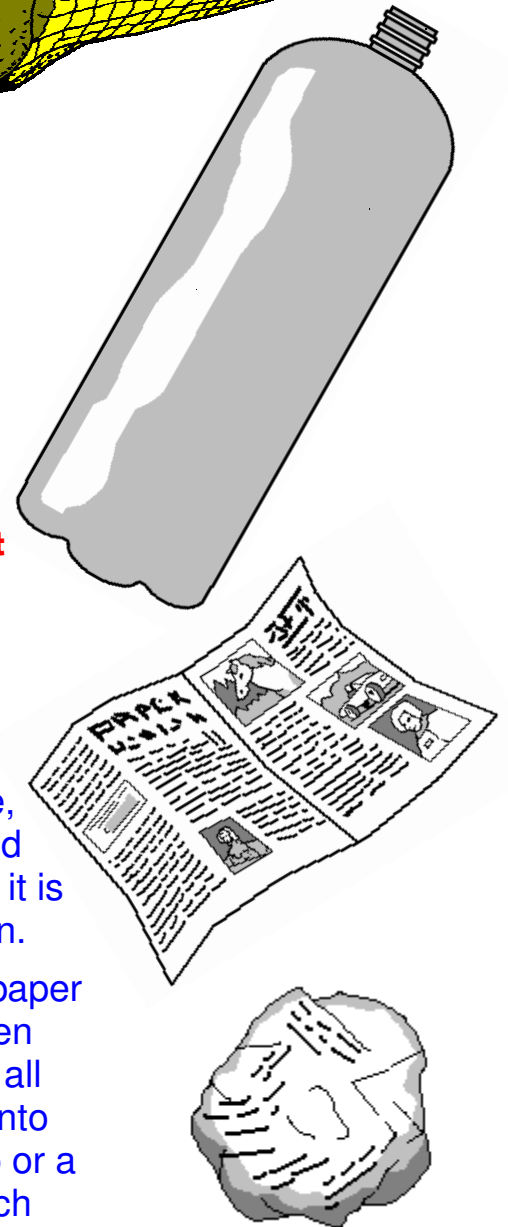

FOR MORE INFORMATION ON THE WORK OF ANTHONY JAMES LOG ON TO WWW.CREATURAMA.COM.

STEP 2 the legs

You should now have a bottle completely covered in crinkled newspaper, creating crinkly dinosaur skin and allowing the model to be painted later. You now need to create the legs. Legs can be created from toilet or Kitchen rolls. If you do use Kitchen rolls cut these in half so your dinosaurs legs aren't too long.

Simply flatten the rolls and cut a long thin triangle across them centrally. Keep the card you remove as this can be used later to create spines on your creature. Once you have cut these triangles out of the four tubes you are using for legs push them back into 3D tubes and then fold them together, fixing with masking tape.

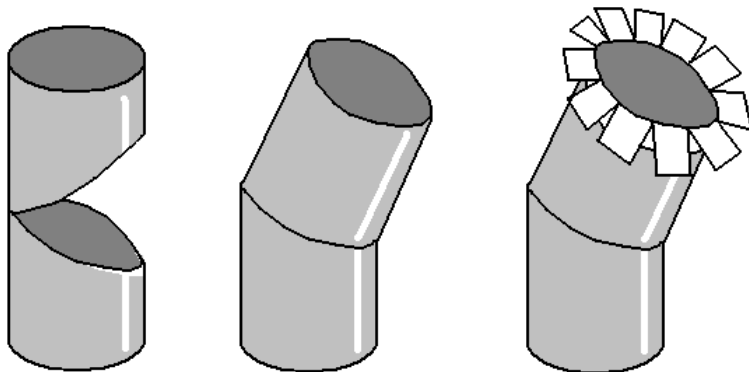
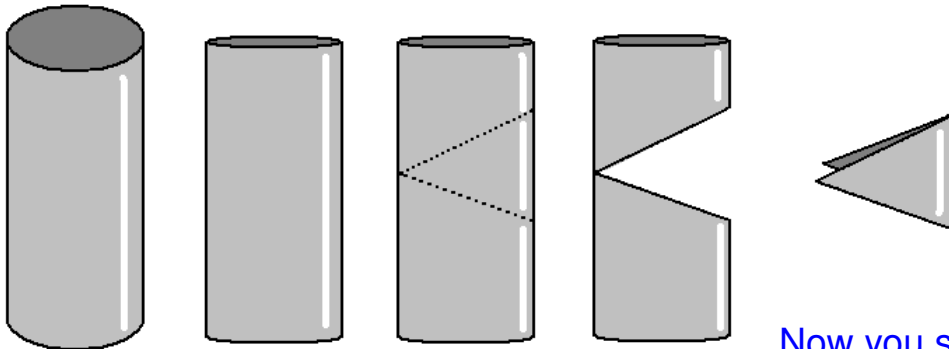

Now you should have four tubes that have now effectively got knees. These now need to be attached to the dinosaurs body. Do this by wrapping a piece of masking tape, half on and half off at one end. Now cut the sticking up tape into a series of petals with which they can now be attached. Ensure that when you are attaching these legs that they are positioned facing outwards from the body. You will soon see how this works if your dinosaur stands up.

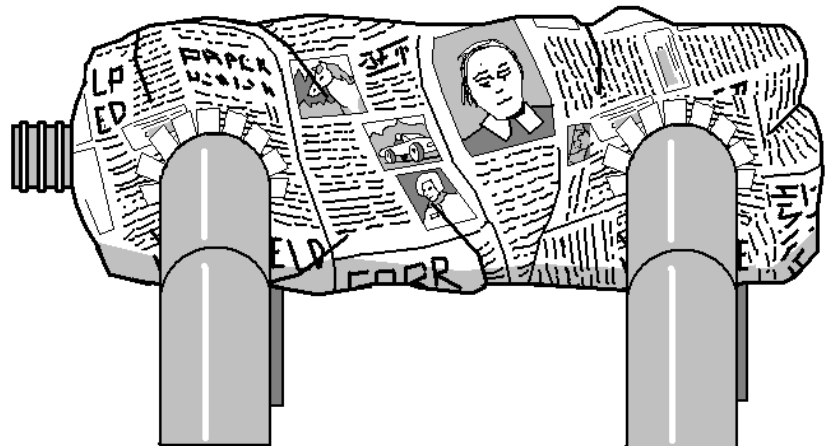
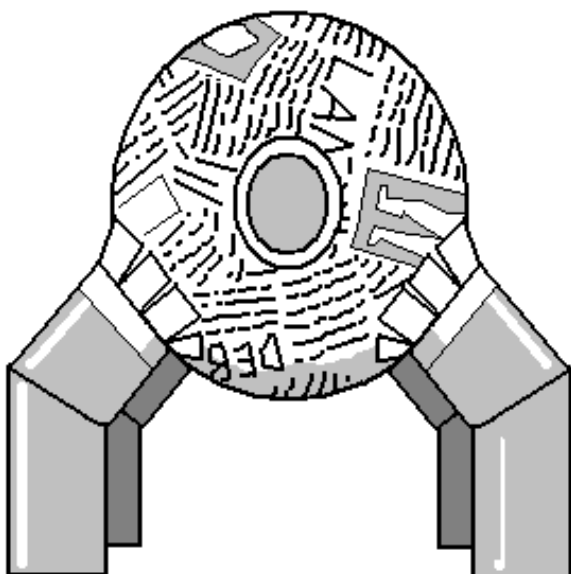
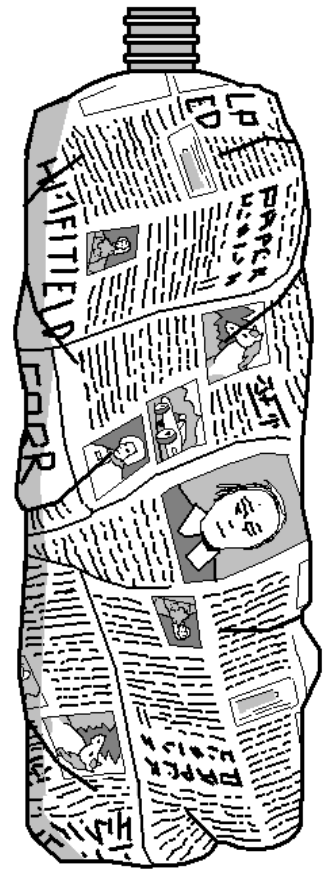

FOR MORE INFORMATION ON THE WORK OF ANTHONY JAMES LOG ON TO WWW.CREATURAMA.COM.

STEP 3 the tail.

The tail can be created using a cereal box. Cut down one corner of a standard cereal box and then open the bottom flaps so that you are left with just a large sheet of card. Use the side without any wording or graphics on so that you can paint it later. Now cut out a VERY large triangle trying to use as much of the card as possible.

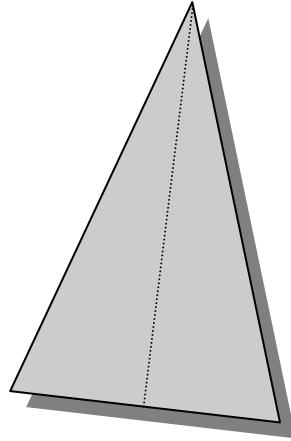
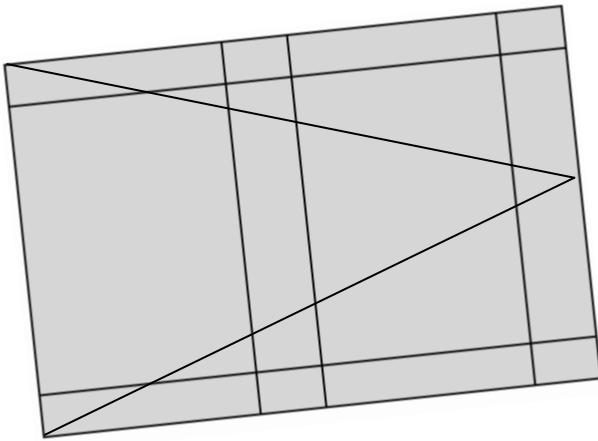
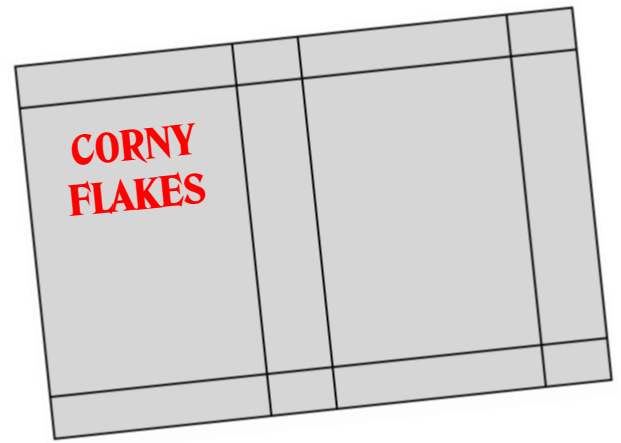

Now you can fold this triangle in half, down its length, don't roll it, just fold it as if it's a large paper aeroplane.

Once you have done this masking tape it together down the open side, leaving the end open.

If you wish you can now cut a triangle out of your flat cone, this will mean that when you squeeze the cone back into a 3D shape you will have two pieces, that, when reattached will create a bent tail.

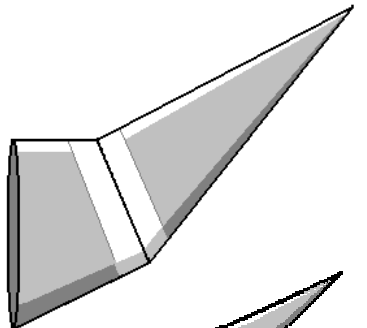
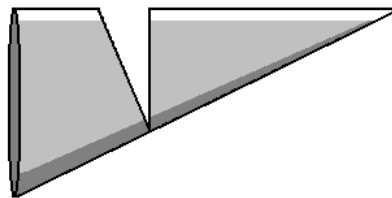
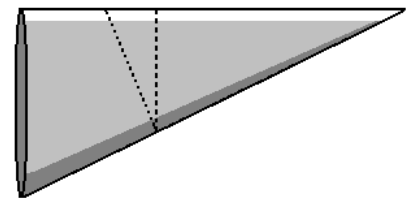
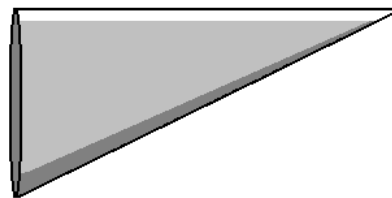

This can then be attached to the body, again with tape. If you have the tail angled upwards just a little bit your dinosaur will look a lot better.

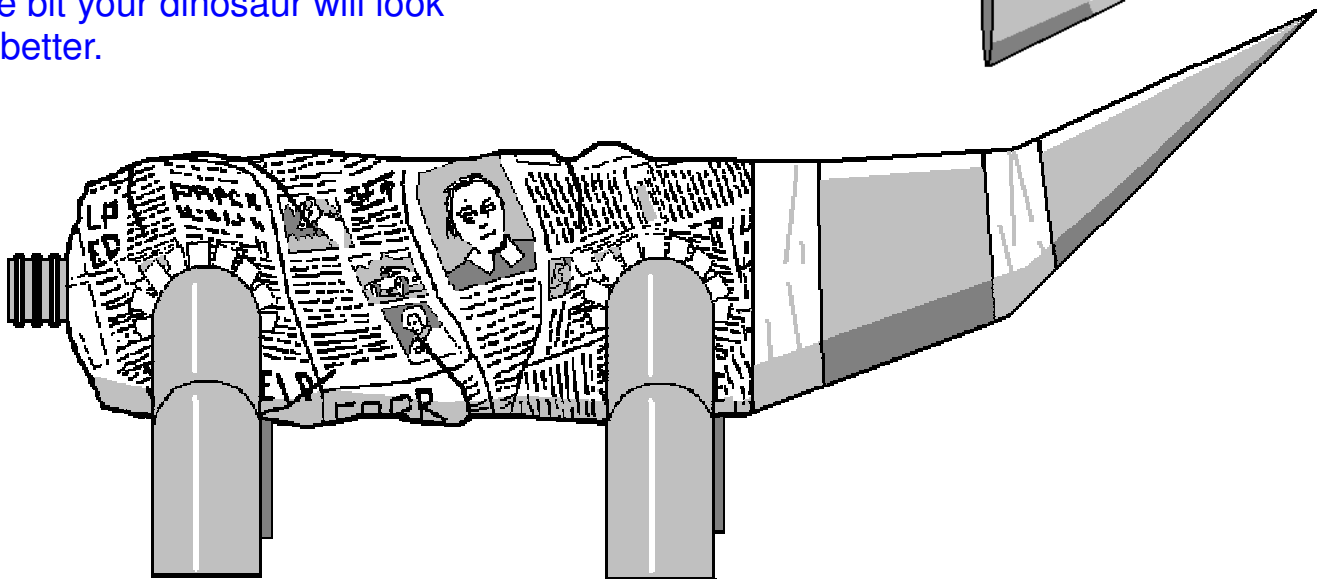

FOR MORE INFORMATION ON THE WORK OF ANTHONY JAMES LOG ON TO WWW.CREATURAMA.COM.

STEP 4 the head.

For the head you will need to cut two shapes from some cereal box card. These are blunt triangles as shown and once cut need to be folded in half along their lengths. While folded cut off the ends and then stick this little cut back together with a tiny piece of masking tape. Teeth can also be cut from these shapes while they are folded flat.

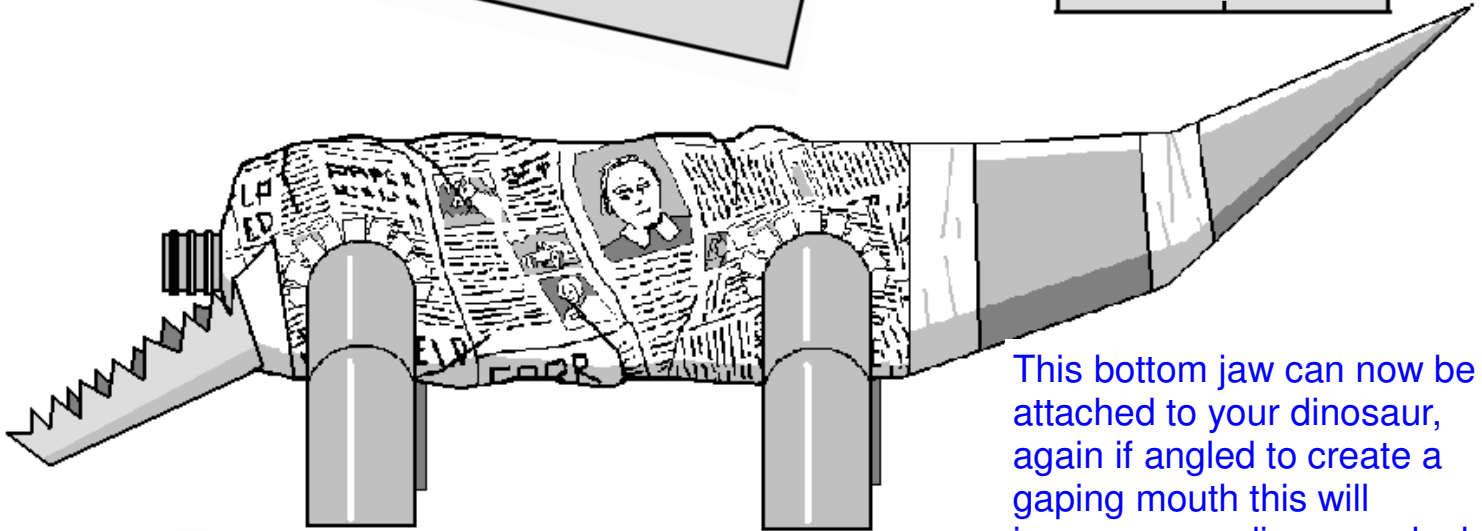
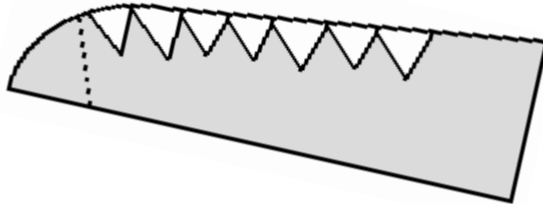
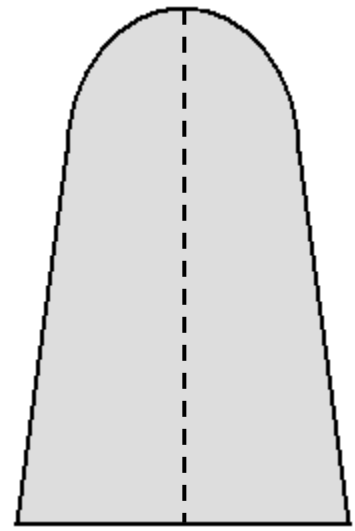

This bottom jaw can now be attached to your dinosaur, again if angled to create a gaping mouth this will improve your dinosaurs look.

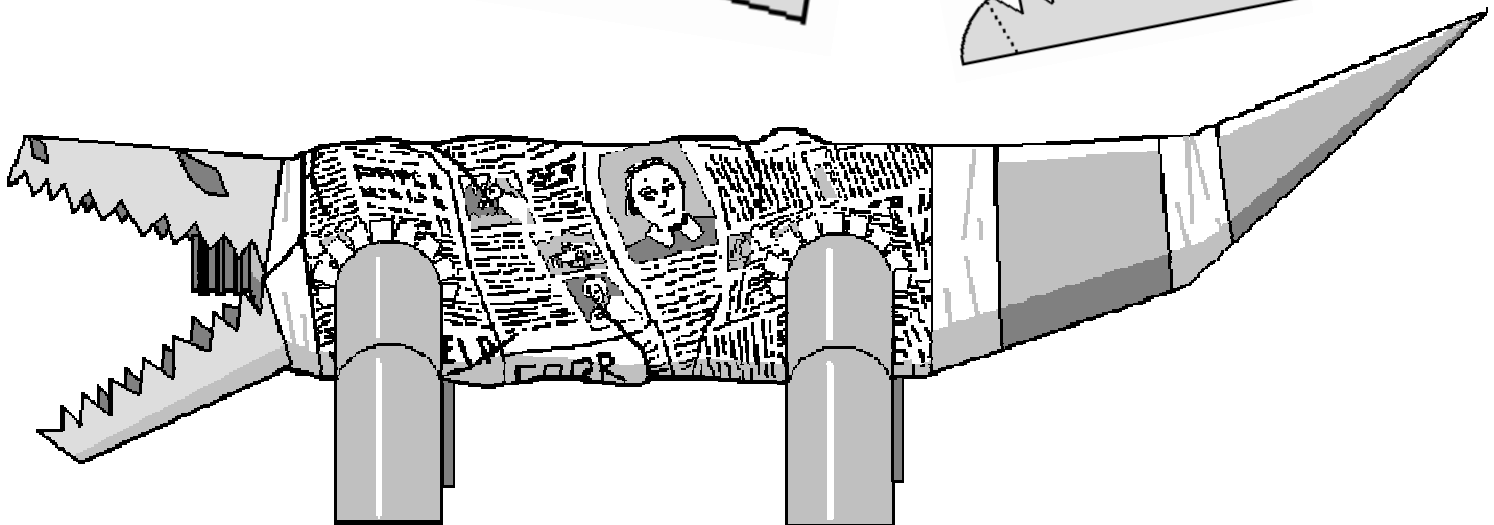
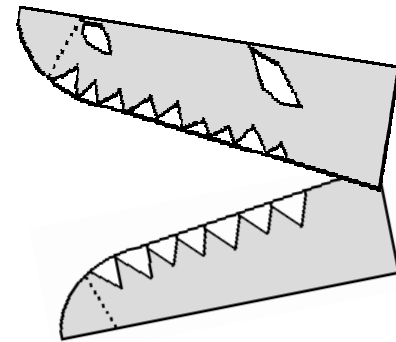
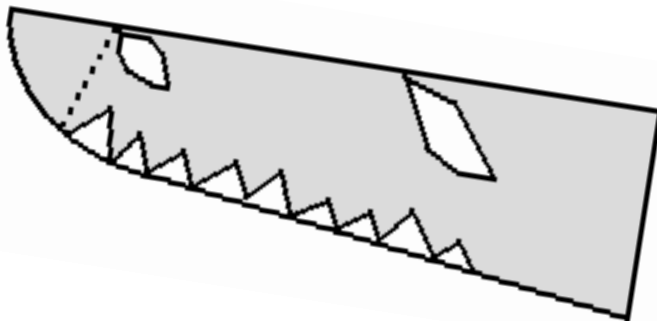

FOR MORE INFORMATION ON THE WORK OF ANTHONY JAMES LOG ON TO WWW.CREATURAMA.COM.

STEP 5 the finishing touches.

Once you've attached the head your nearly done. You can now use the centre pieces of folded card left over from when you created the legs, to create spinal plates if you wish, just to jazz up your Prestosuchus. You just put a thin piece of tape into the middle of these and place where wanted, claws can be created from simple triangular pieces of cereal bow card, folded lengthways and attached to the front of the legs.

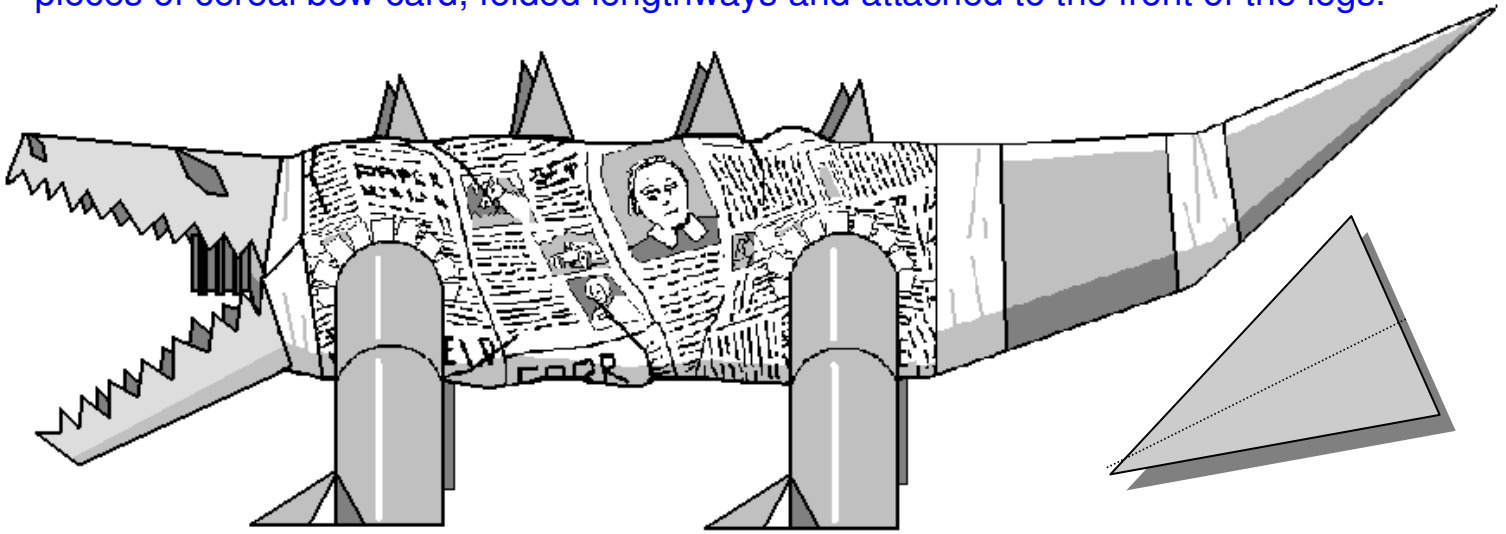

Painting

You can paint your Prestosuchus any colours you wish, as no-one really knows what colour they really were but I would paint your model all **ONE** colour first, let this dry, then add stripes, spots and whatever decorations you wish to create your very own.....

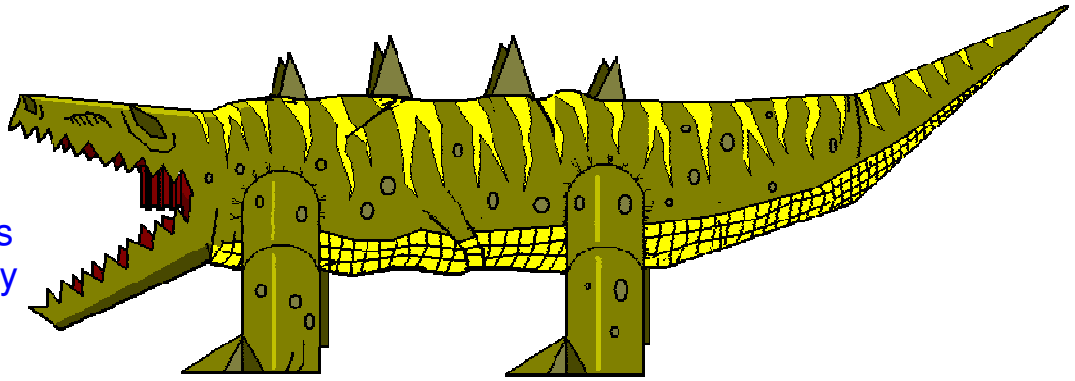

CREATURAMA DINOSAUR

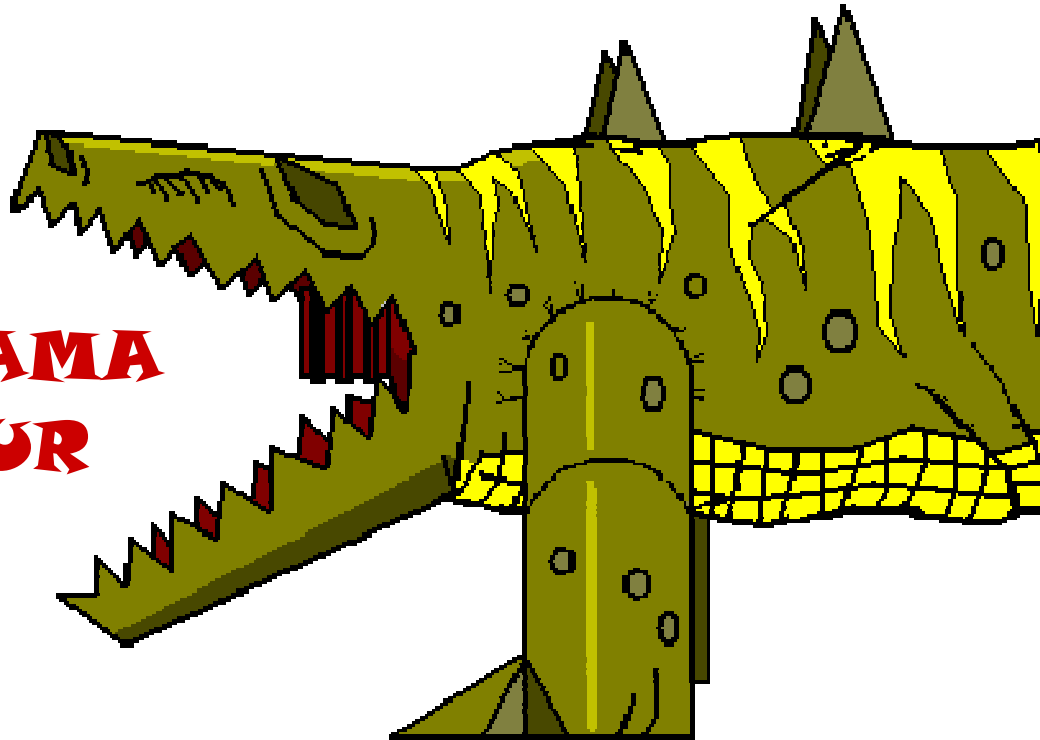

FOR MORE INFORMATION ON THE WORK OF ANTHONY JAMES LOG ON TO WWW.CREATURAMA.COM.